

# 产品规格书

## Product Specification Book

客户名称 /Customer name	湖南银杏电池智能管理技术有限公司
产品名称 /Product Name	HNYX25-15~24 串 20~100A 硬件板 三元系列
产品型号 /Model Name	HETxxMxxT000
功率输出方式 /Output Mode	Power MOSFET
产品工艺 /Product Technology	PCBA 喷三防漆
发布日期 Date	2023.10.31
有效期 Period of Validity	2024.10.31

银杏审核签字 Signature by Ginkgo				客户签字或盖章 Seal or Signature by Customer
编制 Prepared	审核 Checked	复核 Reviewed	批准 Approved	



## 目录

<b>1 产品简介 (Product introduction)</b> .....	<b>4</b>
<b>2 功能示意框图 (Function Block Diagram)</b> .....	<b>4</b>
<b>3 功能配置 (Configuration)</b> .....	<b>5</b>
<b>4 参数设置(Parameter settings)</b> .....	<b>6</b>
4.1 基本参数 (Basic Parameter) .....	6
4.2 主要参数 (Main Parameter Parameters) .....	6
<b>5 关键物料清单 (Bill Of Critixal Materials)</b> .....	<b>9</b>
<b>6 产品示意图及尺寸 (Product Diagram and Dimensions)</b> .....	<b>10</b>
6.1 产品实物图及接口(Product Photos and Interface) .....	10
6.2 电压采样接口定义 (Cell Voltage Sampling Interface) .....	11
6.3 温度采样接口定义 (Temperature Sampling Interface) .....	11
6.4 通信接口定义 (Communication Interface) .....	11
6.5 产品结构尺寸图 (Product Dimensions) .....	12
<b>7 产品安装说明 (Product Setup Instructions)</b> .....	<b>13</b>
7.1 充放电接线示意图 (Charge and Discharge Wiring Diagram) .....	14
7.2 产品结构尺寸图 (Product Dimensions) .....	15
7.2.1 上电顺序 (Power Up Sequence) .....	15
7.2.2 下电顺序 (Power Down Sequence) .....	15
7.3 串数兼容列表 (Strings Number Compatibility List) .....	15
7.4 温度传感器安装 (Temperature Sensor Installation) .....	16
7.5 电气接线说明 (Electrical Wiring Instructions) .....	16
7.6 BMS 开箱检查及注意事项 (BMS Unpacking Inspection and Precautions) .....	17
7.7 线束整理 (Wiring Harness Organization) .....	18
7.8 连接器点胶固定 (Securing Connector With Adhesive) .....	19
7.9 蓝牙/GPS 模块安装 (Installation Of BLE/GPS) .....	20
7.10 装配注意事项 (Assembly Precautions) .....	20
<b>8 免责声明 (Disclaimer)</b> .....	<b>20</b>
<b>9 联系我们 (Contact Us)</b> .....	<b>21</b>

## 1. 产品简介 (Product introduction)

1.1 HNYX25-24S 系列是专门针对 15~24 串和控制 B-输出,锂电池包而设计的硬件保护板,可适用不同材料的电池,如锂离子、聚合物、磷酸铁锂、钠离子、锰酸锂等;

HNYX25-24S is a hardware protection board scheme specially designed for 15~24 series battery packs and controls the B- output. It is compatible with batteries of various materials, such as lithium-ion, polymer, lithium iron phosphate, sodium ion, and lithium manganese oxide.

1.2 产品型号信息 (Ordering Information) :

HETxxMxxxT0000

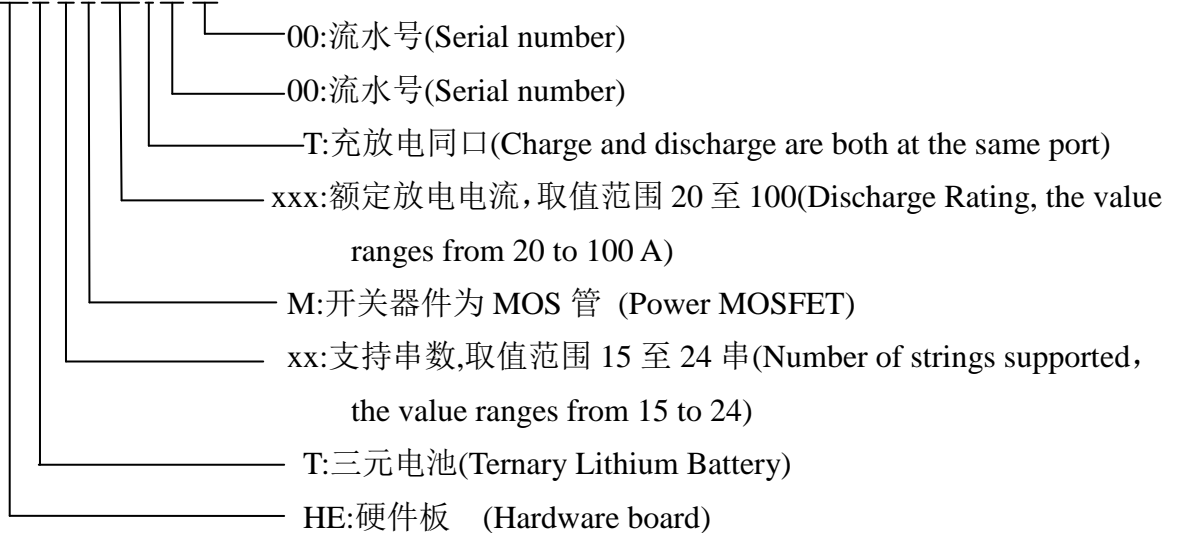

## 2. 功能示意框图 (Function Block Diagram)

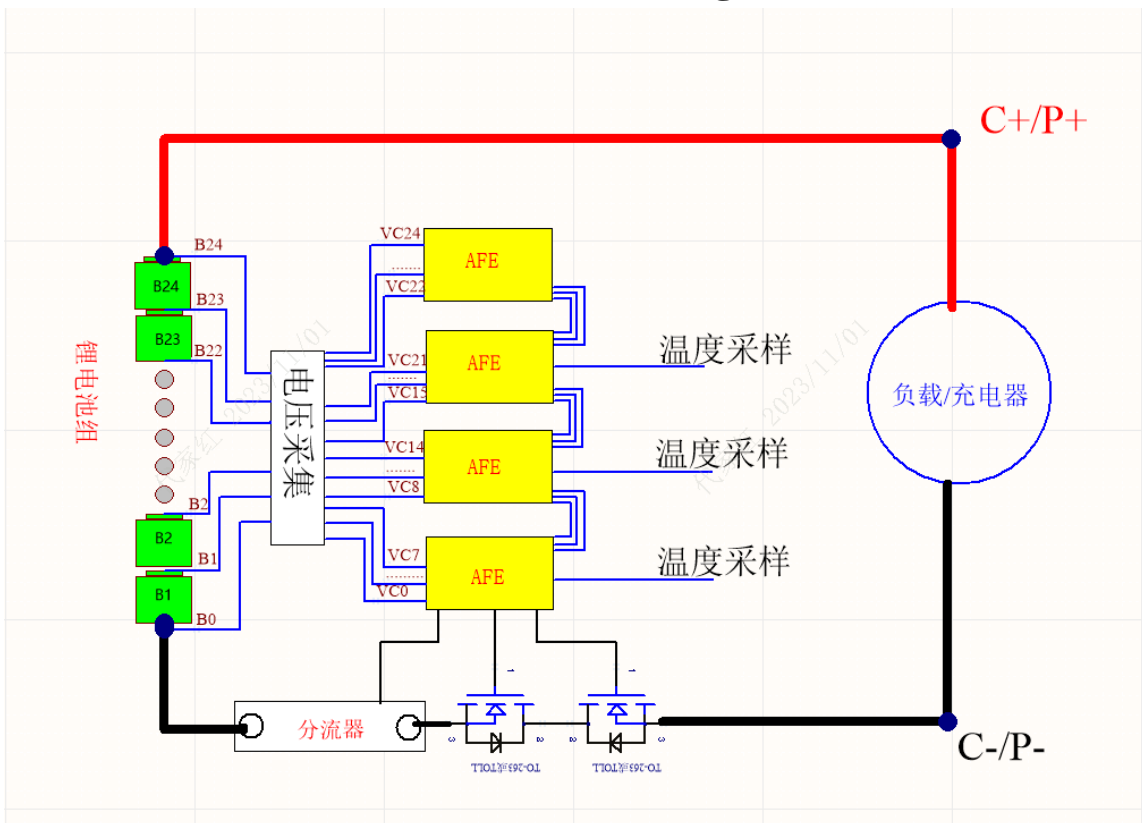

## 3. 功能配置 (Configuration)

功能 (Function)	配置 (Configuration)	功能 (Function)	配置 (Configuration)
支持串数 Number of strings supported	15~24S	485(隔离)485 Communication(Isolated)	
放电持续电流 Discharging Continuous current	20~100A	UART(隔离) UART Communication (Isolated)	/
充电持续电流 Charging continuous current	20~100A	CAN 通讯 CAN Communication (Isolated)	/
NTC 数量 Number of NTCs	2 路电池 (Two temperature probes for battery) 1 路 MOS(One temperature probe for MOS)	加热功能 Heating Function	/
均衡功能	被动均衡 (Passive balance)	蓝牙模块	

Balance Function		Bluetooth Module	
开关功能		电池组串联	/
Switch Function		Battery packs in series	
充电限流功能	不支持	二次保护功能	/
Charging current limit	(Not supported)	Secondary protection	
电池组并联	不支持	LCD 显示屏	/
Battery packs in parallel	(Not supported)	LCD Display	
履历	/	LED 指示灯接口	/
History storage		LED indicator interface	
预放电功能	/	GPS 接口	/
Pre-discharge function		GPS interface	

## 4. 参数设置 (Parameter settings)

### 4.1 基本参数 (Basic parameter)

电池包规格(battery pack Specifications)	15~24 串三元 (15~24 Strings of Ternary Lithium Battery)
接口类型(Interface type)	充放电同口 (Charge and discharge are both at the same port)
充电电压(Charging voltage)	4.25V*串数 (4.25V*Number of Strings)
单体电压范围(Cell voltage range)	2.7~4.25V
持续充电电流 (Continuous charging current)	20~100A
持续放电电流 (Continuous discharging current)	20~100A
通信接口 (Communication Interface)	/
连接上位机波特率, ID(Connected upper computer Baud Rate and ID)	
动行功耗(Consumption of running)	≤60uA
休眠功耗(Consumption of sleep)	≤10uA
休眠条件(Sleep conditions)	保护状态下 (protection state)

深度休眠功耗 (Consumption of deep sleep)	/
深度休眠条件(Deep sleep conditions)	/
工作温度(Operating temperature)	-40°C~70°C
板子结构尺寸(Size)	电流 20&40A, 尺寸 80mm*60mm*13mm±1mm; 电流 80A, 尺寸 90mm*60mm*13mm±1mm; 电流 60A, 尺寸 105mm*60mm*13mm±1mm; 电流 100A, 尺寸 125mm*60mm*13mm±1mm; (长度*宽度*高度)

## 4.2 主要参数 (Main Parameter Parameters)

项目 Project		规格 (Specification)			
		最小 MIN	典型 TYP	最大 MAX	单位 Unit
<b>4.2.1 单串电池参数(Cell Parameter)</b>					
单节过充保护 Single Cell Over-Charge Protection	过充保护 Over-Charge Voltage Protection	4.225	4.25	4.275	V
	过充保护延时时间 Over-Charge voltage Protection Delay Time	800	1000	1200	mS
	过充保护恢复电压 Over-Charge voltage Protection Release	4.125	4.15	4.175	V
单节过放保护 Single Cell Over-Discharge Protection	过放保护 Over-Discharge Voltage Protection	2.67	2.70	2.73	V
	过放保护延时时间 Over-Discharge voltage Protection Delay Time	800	1000	1200	mS
	过放恢复电压 Over-Discharge voltage Protection Release	2.975	3.00	3.03	V
<b>4.2.2 均衡功能 (Balance Function)</b>					
	均衡开启电压	4.1	4.125	4.15	V

均衡电压 Balanced Voltage	Balanced Opening Voltage				
	均衡开启压差 Balanced Opening Voltage Different		/		V
	均衡电流 Balanced Opening Current		50		mA
	均衡方式 Balanced Opening Mode	被动均衡			\
<b>4. 2. 3 电流保护参数(Current Protection Parameter)</b>					
充电过流保护 Over Charge Current Protection	充电过流保护电流 Over-Current Charge Protection	额定 电流 *0.75	额定 电流	额定 电流 *1.25	A
	充电过流保护延时 Over-Current Charge Protection Delay Time	400	500	600	mS
	充电过流保护解除 Over-Current Charge Protection is lifted	移除充电器 remove the charger to restore			
放电过流保护 Over Discharge Current Protection	一级放电过流保护电流 1th Ove Protection Current	额定 电流 *2.25	额定 电流 *2.5	额定 电流 *2.75	A
	一级放电过流保护延时 1th Over Protection Delay Time	800	1000	1200	mS
	二级放电过流保护电流 2nd Level Over Protection Current	额定 电流 *4.5	额定 电流 *5	额定 电流 *5.5	A
	二级放电过流保护延时 2nd Level Over Protection Current Delay Time	90	100	110	mS
	放电过流保护解除 Over-Current Discharge Protection Release	移除负载 remove the load to restore			
<b>4. 2. 4 短路保护参数 (Short-Circuit Protection Parameter)</b>					
短路保护 Shor-Circuit Protection	短路保护电流 Short-Circuit Protection Current	额定 电流 *9	额定 电流 *10	额定 电流 *11	A
	短路保护延时 Short-Circuit Protection Delay Time	180	200	240	uS
	短路保护解除 Short-Circuit Protection is lifted	移除负载解除 Removing the load is lifted			
	短路说明: 表中的短路电流最小值与最大值是短路保护功能的有效作用范围, 电流低于最小值或高于最大值, 都会可能导致短路保护				

	<p>功能失效。请充分评估实际的短路电流值，或者串联电阻，再进行短路测试！</p> <p>Short-Circuit Description: The minimum and maximum values of the short-circuit current listed in the table define the effective range of the short-circuit protection function. If the current is lower than the minimum value or higher than the maximum value, it may cause the short-circuit protection to fail. Please thoroughly assess the actual short-circuit current value or series resistance before conducting short-circuit tests.</p>
--	--

#### 4. 2. 5 电池温度保护参数（Cell Temperature Protection Parameter）

充电温度保护 Charging Temperature Protection	充电高温保护 Charging High Temperature Protection	52	55	58	°C
	充电高温恢复 Charging High Temperature Protection Release	47	50	53	°C
	充电低温保护 Charging Low Temperature Protection	-2	-5	-8	°C
	充电低温恢复 Charging Low Temperature Protection Release	3	0	-3	°C
放电温度保护 Discharging Temperature Protection	放电高温保护 Discharging High Temperature Protection	57	60	63	°C
	放电高温恢复 Discharging High Temperature Protection Release	47	50	53	°C
	放电低温保护 Discharging Low Temperature Protection	-22	-25	-28	°C
	放电低温恢复 Discharging Low Temperature Protection Release	-17	-20	-23	°C

#### 4. 2. 6 MOS 温度保护参数（MOS Temperature Protection Parameter）

MOS 高温保护 High Temperature Protection of MOS	MOS 温度保护值 Temperature Protection Value	85	90	95	°C
	MOS 温度保护解除值 Temperature Protection Release Value	65	70	75	°C

#### 4. 2. 7 电池总压保护参数（Total Voltage Protection Parameter）

	总压过充保护电压	/	/	/	V
--	----------	---	---	---	---

总压过充保护 Total Voltage Over charge Protection	Overall Overcharge Protection Voltage				
	总压过充保护延时 Overall Overcharge Protection Delay	/	/	/	mS
	总压过充保护解除电压 Overall Overcharge Protection Release Voltage	/	/	/	V
总压过放保护 Total Voltage Over discharge Protection	总压过放保护电压 Overall Over discharge Protection Voltage				V
	总压过放保护延时 Overall Over discharge Protection Delay				mS
	总压过放保护解除电压 Overall Over discharge Protection Release Voltage				V
<b>4.2.8 加热管理 (Heating Manage)</b>					
加热管理 Heating Manage	加热开启温度 Heating Opening temperature		/		°C
	加热停止温度 Heating Stop temperature		/		°C
	加热电流 Heating Current	/			A
	加热方式 Type Of Heating	/			

## 5. 关键物料清单 (Bill Of Critical Materials)

序号 (NO)	物料名称 (Name of Material)	生产厂家 (Manufacturer)	封装 (Packaging)	数量 (Quantity)
1	CW1274	赛威	SSOP24	1
2	/	/	/	/
3	/	/	/	/

重点说明：为保障供应链的安全，所有 BMS 物料，尤其是关键器件我司都会有同品质同规格的替代方案，如有认证需求不允许更换或需经客户端确认才能更换物料，需通知我司业务重新送样方案，并确认规格书。

Note: To ensure the safety of the supply chain, we have alternative materials of the same quality and specifications for all Battery Management System (BMS) materials, particularly the key components. If there are certification requirements where replacement is not allowed, or if a client's

approval is required for replacement, please notify our sales representatives to resend sample proposals and confirm the product specification.

## 6. 产品示意图及尺寸 (Product Diagram and Dimensions)

### 6.1 产品实物图及接口 (Product Photos and Interface)

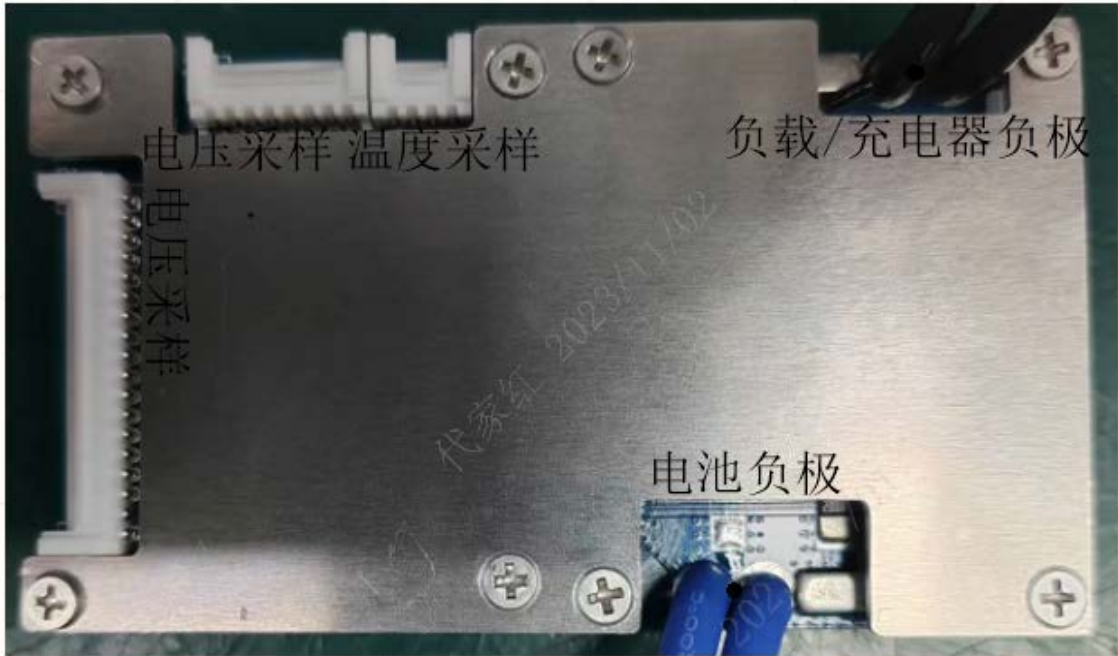

### 6.2 电压采样接口定义 (Cell Voltage Sampling Interface)

电池采样线束接口定义 Cell Voltage Sampling Interface					
NO	PIN	PIN 功能定义 (Pin Function)	NO	PIN	PIN 功能定义 (Pin Function)
1	B0	接 1 串电池负极 Connect to Negative side of cell 1	14	B13	第 13 串电池正极 Connect to Positive side of cell 13
2	B1	第 1 串电池正极 Connect to Positive side of cell 1	15	B14	第 14 串电池正极 Connect to Positive side of cell 14
3	B2	第 2 串电池正极 Connect to Positive side of cell 2	16	B15	第 15 串电池正极 Connect to Positive side of cell 15
4	B3	第 3 串电池正极 Connect to Positive side of cell 3	17	B16	第 16 串电池正极 Connect to Positive side of cell 16
5	B4	第 4 串电池正极 Connect to Positive side of cell 4	18	B17	第 17 串电池正极 Connect to Positive side of cell 17
6	B5	第 5 串电池正极 Connect to Positive side of cell 5	19	B18	第 18 串电池正极 Connect to Positive side of cell 18
7	B6	第 6 串电池正极 Connect to Positive side of cell 6	20	B19	第 19 串电池正极 Connect to Positive side of cell 19
8	B7	第 7 串电池正极 Connect to Positive side of cell 7	21	B20	第 20 串电池正极 Connect to Positive side of cell 20

9	B8	第 8 串电池正极 Connect to Positive side of cell 8	22	B21	第 21 串电池正极 Connect to Positive side of cell 21
10	B9	第 9 串电池正极 Connect to Positive side of cell 9	23	B22	第 22 串电池正极 Connect to Positive side of cell 22
11	B10	第 10 串电池正极 Connect to Positive side of cell 10	24	B23	第 23 串电池正极 Connect to Positive side of cell 23
12	B11	第 11 串电池正极 Connect to Positive side of cell 11	25	B24	第 24 串电池正极 Connect to Positive side of cell 24
13	B12	第 12 串电池正极 Connect to Positive side of cell 12	26		

### 6.3 温度采样接口定义 (Temperature Sampling Interface)

温度线束接口定义 Temperature Sampling Interface					
NO	PIN	PIN 功能定义 (Pin Function)	NO	PIN	PIN 功能定义 (Pin Function)
1	T1+	温度传感器 1 正极 Positive side of temperature sensor1	3	T2+	温度传感器 2 正极 Positive side of temperature sensor 2
2	T1-	温度传感器 1 负极 Negative side of temperature sensor1	4	T2-	温度传感器 2 负极 Negative side of temperature sensor 2

## 6.4 产品结构尺寸图 (Product Dimensions)

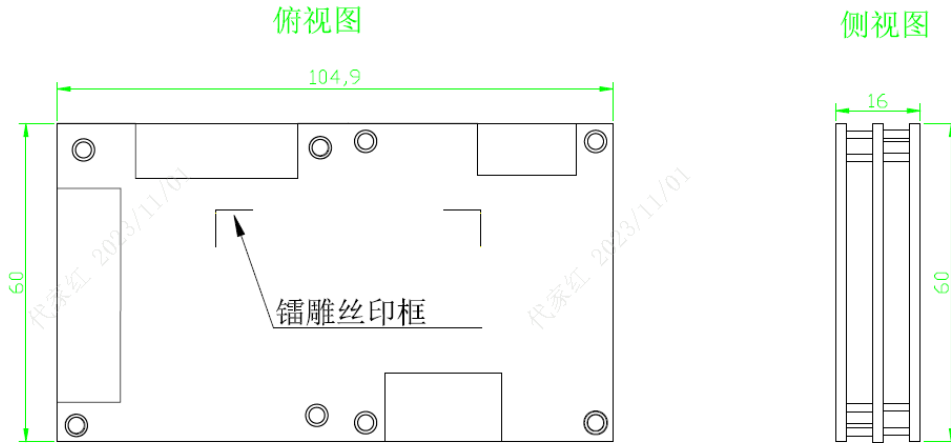

## 7. 产品安装说明 (Product Setup Instructions)

### 7.1 充放电接线示意图 (Charge and Discharge Wiring Diagram)

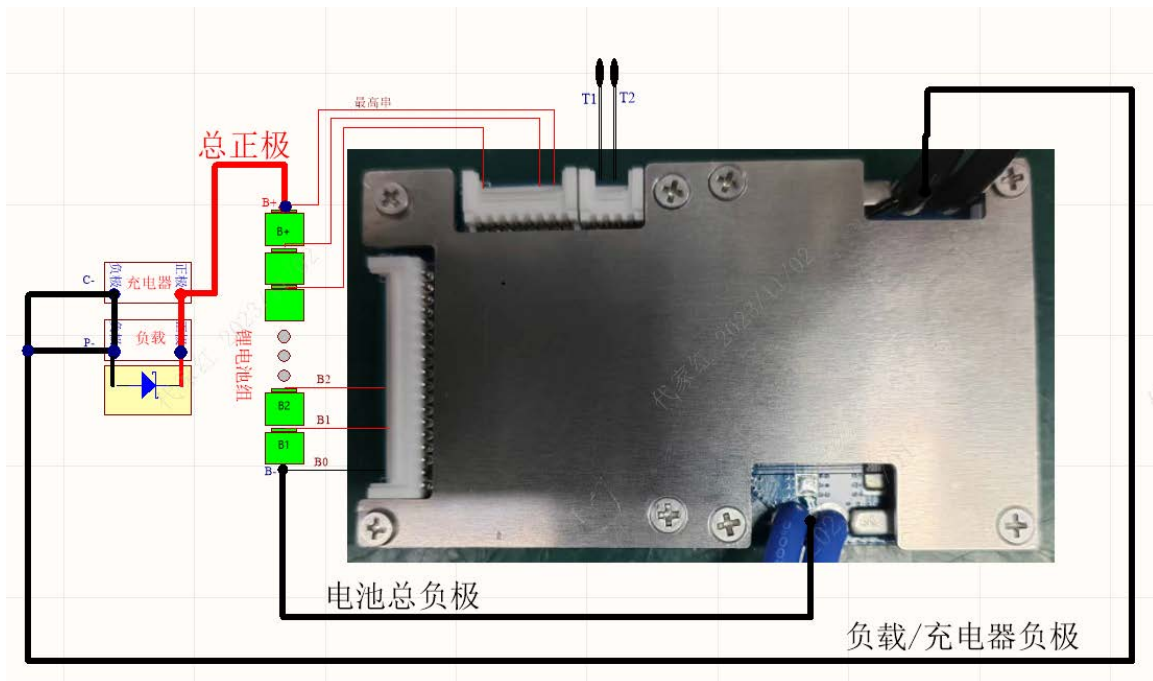

## 7.2 电气接线顺序(Order of Connection)

### 7.2.1 上电顺序(Power Up Sequence):

第一步：连接主板 B-到电池包的负极；

Step 1: Connect the main board "B-" to the negative terminal of the battery pack.

第二步：接入温度传感器线束

Step 2: Connect the temperature probes cable

第三步：连接电池采集线束；

Step 3: Connect the cell voltage sensing cable.

第四步：连接“P-”动力线到负载负极或充电器负极，或“C-”动力线到充电器负极；

Step 4: Connect the “P-” wire to the negative of the load or the charger, or connect the “C-” wire to the negative of the charger.

第五步：确保以上连接正确后，启动负载或充电器

Step 5: After ensuring all the above connections are correct, Starting load or charger.

### 7.2.2 下电顺序(Power Down Sequence):

第一步：断开充电器和负载；

Step 1: Disconnect the charger and load.

第二步：断开电压采集线；

Step 2: Disconnect the voltage sensing cable.

第三步：断开所有通讯线；

Step 3: Disconnect all communication cables.

第四步：断开主板 B-。

Step 4: Disconnect the main board B-.

注：如果电压采集线为焊接方式的：

Note: If the voltage sensing line is welded:

A: 提前加工：将 BMS 放置在防静电桌面上，操作员手持烙铁在待焊接焊盘上加锡，待焊接物料如来料时未加锡处理，也需提前进行加锡，以减少带电焊接时的焊接时间。

A: Pre-processing: Place the BMS on an anti-static desktop, with the operator using a soldering iron to tin the solder pad that's to be welded. If the materials to be soldered weren't tinned upon arrival, it is also necessary to tin them in advance to reduce the welding time during live soldering.

B: 焊接顺序：电池采集线焊接顺序为 B1 → B2 · · · · B+，确认焊接无误后，才能上电。

B: Welding sequence: The welding sequence for the battery sensing line is B1 → B2 ... B+. Only after confirming that the welding is correct should you power on.

C: 焊接过程中避免碰到周边元件及周边的 PCB 线路。

C: Avoid contacting surrounding components and PCB circuits during the welding process.

### 7.3 串数兼容列表 (Strings Number Compatibility List)

BMS 连 接器端 BMS Interface	电池端 PACK Configuration							
	24S	21S	20S	19S	18S	17S	16S	15S
B24	B24	B21						
B23	B23	B20						
B22	B22	B19						
B21	B21	B18						
B20	B20		B20					

<b>B19</b>	<b>B19</b>		<b>B19</b>	<b>B19</b>				
<b>B18</b>	<b>B18</b>	<b>B17</b>	<b>B18</b>	<b>B18</b>	<b>B18</b>	<b>B17</b>	<b>B16</b>	<b>B15</b>
<b>B17</b>	<b>B17</b>	<b>B16</b>	<b>B17</b>	<b>B17</b>	<b>B17</b>	<b>B16</b>	<b>B15</b>	<b>B14</b>
<b>B16</b>	<b>B16</b>	<b>B15</b>	<b>B16</b>	<b>B16</b>	<b>B16</b>	<b>B15</b>	<b>B14</b>	<b>B13</b>
<b>B15</b>	<b>B15</b>	<b>B14</b>	<b>B15</b>	<b>B15</b>	<b>B15</b>	<b>B14</b>	<b>B13</b>	<b>B12</b>
<b>B14</b>	<b>B14</b>		<b>B14</b>	<b>B14</b>	<b>B14</b>			
<b>B13</b>	<b>B13</b>	<b>B13</b>	<b>B13</b>	<b>B13</b>	<b>B13</b>	<b>B13</b>		
<b>B12</b>	<b>B12</b>	<b>B12</b>	<b>B12</b>	<b>B12</b>	<b>B12</b>	<b>B12</b>	<b>B12</b>	
<b>B11</b>	<b>B11</b>	<b>B11</b>	<b>B11</b>	<b>B11</b>	<b>B11</b>	<b>B11</b>	<b>B11</b>	<b>B11</b>
<b>B10</b>	<b>B10</b>	<b>B10</b>	<b>B10</b>	<b>B10</b>	<b>B10</b>	<b>B10</b>	<b>B10</b>	<b>B10</b>
.....	.....	.....	.....	.....	.....	.....	.....	.....
<b>B0</b>	<b>B-</b>	<b>B-</b>	<b>B-</b>	<b>B-</b>	<b>B-</b>	<b>B-</b>	<b>B-</b>	<b>B-</b>

注：颜色区域表示电压采集线悬空。

Note:Color areas indicate voltage acquisition overhangs."



**Color mean: these wires merge**

## 7.4 温度传感器安装(Temperature Sensor Installation)

主板上温度传感器用于监测电池包温度，安装时，请将探头紧贴在位于电池组中间位置的单体电池上，确保测量到电池组温度最集中的地方。

The temperature sensor on the main board is used to monitor the temperature of the battery pack. During installation, please place the sensor probe closely against a single cell located in the middle of the battery pack, ensuring it measures at the most concentrated heat area of the pack.

## 7.5 电气接线说明(Electrical Wiring Instructions)

- 7.5.1 将 BMS 连接到电池组时，首先应将电池组总负极连接到 BMS 的 B-，确保系统可靠接地。同时，电池组总负极到 BMS 板 B-端动力线阻抗应尽量低，控制在  $0.1\text{m}\Omega$  以内，以确保在大电流充、放电时的电流检测精度；

When connecting the BMS to the battery pack, first connect the overall negative terminal of the battery pack to the B- terminal of the BMS, ensuring a reliable grounding of the system. At the same time, the impedance of the power line from the overall negative terminal of the battery pack to the B- terminal on the BMS board should be kept as low as possible, ideally within  $0.1\text{m}\Omega$ , to ensure accurate current detection during high-current charging and discharging.

- 7.5.2 在做充放电大于 50A 电流测试时，主板上的 B-和 P-动力线必须全部接上，以确保过电流能力，并保证功率器件均流。

When conducting tests with charge and discharge currents greater than 50A, both the B- and P- power lines on the main board must be fully connected to ensure overcurrent capability and to guarantee even current distribution across power devices.

## 7.6 BMS 开箱检查及注意事项(BMS unpacking inspection and precautions)

- 7.6.1.1 开箱前注意包装是否完好，如有无撞击痕迹、有无破损等；对包装箱、BMS 等 需要轻拿轻放、尽量不要倒置。

Before opening the box, check if the packaging is intact, looking for any signs of impact or damage. Handle the packaging box and the BMS gently, and try to avoid placing them upside down.

- 7.6.1.2 安装 BMS 之前，电池一定要匹配好，上电电压太高或太低会导致 BMS 告警，而无法正常工作，如果电芯电压是已经过充或过放，请把电芯电压充或放电到正常电压再连接 BMS。

Before installing the BMS, ensure that the battery cells are properly matched. A voltage that is too high or too low will trigger an alarm in the BMS, preventing it from functioning correctly. If the battery cell's voltage is overcharged or over-discharged, adjust the voltage to its normal range before connecting it to the BMS.



## 7.7 线束整理(Wiring harness organization)

线束整理取决于连接器的设计及线束出线方向，及线束在连接器内的可能活动需要的活动量，以下标准针对普遍会存在应力的应用。

The arrangement of the wiring harness depends on the design of the connector, the direction of the harness exit, and the amount of movement required by the harness within the connector. The following standards address applications that commonly experience stress.

### A. 直向走线：线束捆扎点在与连接器宽度等长的位置

Straight Wiring: The tie point of the wiring harness is positioned at a length equivalent to the width of the connector.

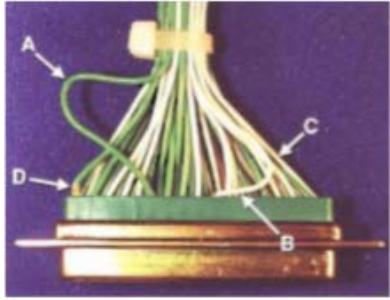
<p>目标（图 A）：线束出线与连接器面垂直；线束捆扎点与连接器之间有足够的距离以防止线束有应力。</p> <p>Objective (Figure A): The wiring harness exit is perpendicular to the connector's surface; there's enough distance between the tie point of the harness and the connector to prevent any stress on the wires.</p>	<p>合格（图 B）：线束出线与连接器而近垂直；线束没有应力。</p> <p>Acceptable (Figure B): The wiring harness exit is almost perpendicular to the connector; the harness is free from stress.</p>	<p>不合格（图 C, A）：线束长度过长；线束出线与连接器面形成锐角（图 C, B）；线束有应力（完全没有移动的余地）</p> <p>Not Acceptable (Figure C,A): The length of the wiring harness is too long; The wiring harness exit forms a sharp angle with the connector's surface (Figure C, B); The harness is under stress (with no room for movement whatsoever).</p>
 <p>图A（1处为高应力区）</p>	 <p>图B</p>	 <p>图C</p>

### B. 侧向走线：线束弯曲点在连接器 1/3 宽度的位置

Lateral wiring: The bending point of the wiring harness is located at 1/3 of the width of the connector

<p>目标（图 A）：线束在弯曲前出线方向应垂直于连接</p>	<p>合格（图 B）：线束出线与连接器面接近垂直。</p>	<p>不合格(图 C):线束长度过长(A); 线束出线与连接器而形成锐角</p>
---------------------------------	-------------------------------	--

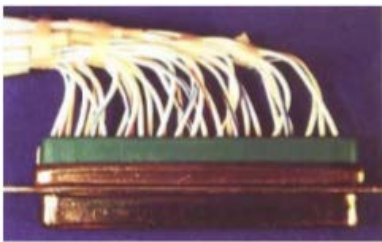
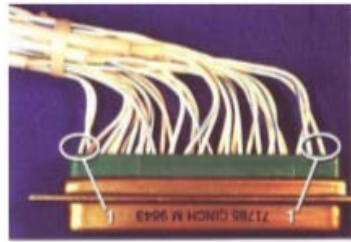
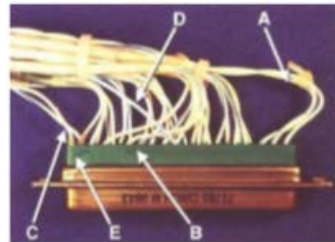
<p>器；线束没有应力；线束没有受到扎带的应力作用；</p> <p>Objective (Figure A):</p> <p>The wire harness should be perpendicular to the connector before any bending; The harness should be free from stress; The harness shouldn't experience stress from any ties.</p>	<p>Acceptable (Figure B): The wire harness exit is nearly perpendicular to the face of the connector.</p>	<p>(B)；线束有应力（没有移动的余地）（C、D）</p> <p>Not Acceptable (Figure C):</p> <ul style="list-style-type: none"> <li>• The wire harness is excessively long (A).</li> <li>• A sharp angle is formed between the wire harness exit and the connector (B).</li> <li>• The wire harness has tension or stress (lacks slack or free movement) (C, D).</li> </ul>
 <p>图A</p>	 <p>图B（1处所指为高应力区）</p>	 <p>图C</p>

### C. 线束固定：

线束需要用卡扣或扎带固定在箱体或安装板上，要求布线整齐、固定牢靠、不可有晃动悬垂、不可有干涉受力、不可有摩擦破损；在连接器 30~50mm 处必须有固定点，两固定点之间间距不得大于 200mm，过拐角棱边两端 80mm 之内应有固定点。

#### C. Wire Harness Fixation:

The wire harness should be securely attached to the enclosure or mounting plate using clips or ties. The wiring should be tidy and stable, with no loose hanging, interference, undue stress, or signs of wear from friction. Fixation points must be positioned 30-50mm from the connector, with no more than 200mm between each fixation point. Additionally, fixation points should be placed within 80mm from both ends when navigating corner edges.

## 7.8 连接器点胶固定(Securing Connector With Adhesive)

线束安装完成后，确保连接器卡扣安装到位，建议在线束胶壳与 BMS 连接器相交位置及卡扣四周打上阻燃的红胶或黄胶（硬胶）进行固定，正反面都需要打胶。

Once the wiring harness installation is finished, ensure the connector's buckle is properly positioned. It's suggested to apply flame-retardant red or yellow adhesive (hard type) at the junction between the wiring harness's protective casing and the BMS connector, as well as around the buckle. Both front and back sides should have adhesive applied.



#### 重点说明:

因电机的控制器均带有续流保护器件，故 BMS 板上未配置大功率续流管，如果使用大型充放电测试柜对电池组进行放电测试时，为防止放电关断瞬间，测试柜产生电感效应，应在测试柜输出端并接续流保护二极管，推荐规格为 200V/100A 的肖特基二极管。否则，测试柜的感应电压有可能损坏 BMS 板上的功率器件。

#### Note:

Since motor controllers come with continuous current protection devices, the BMS board doesn't have high-power continuous current tubes. When using a large-scale charging and discharging test cabinet for battery pack discharge tests, to prevent inductive effects during discharge cut-off, a continuous current protection diode should be added to the test cabinet's output. A 200V/100A Schottky diode is recommended. Failing to do so could result in induced voltages from the test cabinet damaging the power components on the BMS board.

### 7.9 蓝牙/GPS 模块的安装 (Installation of Bluetooth/GPS)

蓝牙/GPS 模块是一个独立模块，为保障信号强度，需要保障蓝牙/GPS 天线不被金属壳体屏蔽，遮挡。

The Bluetooth/GPS module is standalone. To ensure robust signal strength, make sure the Bluetooth/GPS antenna isn't shielded or obstructed by any metal casing.

### 7.10 装配注意事项 (Assembly precautions)

7.10.1 装配和使用中应防止静电，不要用手随意去接触电路板导电的部分；焊接使用的烙铁及装配使用的电动工具必须良好接地。

Avoid static electricity during assembly and use. Refrain from touching the conductive areas of

the circuit board directly with your hands. Ensure that the soldering iron and electric tools used during assembly are properly grounded.

#### 7. 10. 2 装配使用中应避免电路板受力,以免损坏电子元器件,导致电路板失效。

During assembly and use, avoid putting stress on the circuit board to prevent damage to electronic components and potential circuit board failure.

## 8. 免责声明 (Disclaimer)

如果不按要求的顺序作业,会损坏保护板的元器件,从而导致保护板不能保护电芯,造成的后果由用户承担责任。

If procedures are not followed in the specified order, components of the protective board may be damaged, rendering the board unable to safeguard the battery pack. Users will bear responsibility for any resulting consequences.

## 9. 联系我们(Contact Us)

公司：湖南银杏电池智能管理技术有限公司

Company: Hunan Ginkgo Battery Intelligent Management Technology Co., Ltd

地址：湖南省长沙经济技术开发区东六路南段 77 号金科亿达科技城 B49-2 栋

Address: Building B49-2, Jinke Yida Science and Technology City, No. 77, South Section of Dongliu Road, Changsha Economic and Technological Development Zone, Hunan Province

邮政编码：410100

Postal Code: 410100

技术支持：0731-88288662

Technical support: 0731-88288662